

HunterDouglas

Installation • Operation • Care



Roller Shade

Cordless Lifting System
Standard and Cassette

CONTENTS

Getting Started:

Installation Components Needed 1
Tools And Fasteners Needed 2
Mounting Types..... 2
Product Views 3
Mount The Installation Brackets — Standard Cordless 5
Mount The Installation Brackets — Cordless Cassette..... 6

Installation:

Install The Shade 7
Install The Shade Pull 7

Operation:

Operate The Shade 8
Shade Adjustment 8
Troubleshooting 10

Care:

Standard Cordless Shade Removal..... 11
Cordless With Cassette Shade Removal..... 11
Cleaning Procedures 11

Questions?

Call the Hunter Douglas Customer Information Center at
1-888-501-8364.



© 2008 Hunter Douglas Inc.
® Registered trademark of Hunter Douglas Inc. ™ Trademark of Hunter Douglas Inc.
Patented in the U.S. and foreign countries. Other U.S. and foreign patents pending.

GETTING STARTED

Thank you for purchasing Hunter Douglas cordless roller shades. With proper installation, operation and care, your new shades will provide years of beauty and performance. Please thoroughly review this instruction booklet before beginning the installation.

Installation Components Needed

Check the packaging to be sure you have all the components needed to install your shades. Keep the packaging until the shades perform to your satisfaction.

CAUTION: Keep the "Do not remove until installation" paper wrap in place, until shade is completely installed. These instructions will remind you when to remove the wrap.

Required Components

The number of brackets required varies with shade width, as shown in the standard cordless and cordless with cassette bracket tables. The type of bracket varies with standard and cassette shades.

Standard Cordless

■ Installation Bracket Requirements.

Standard Cordless Installation Brackets Required

Shading Width	Brackets Required
12" - 55"	2
55 1/8" - 79"	3

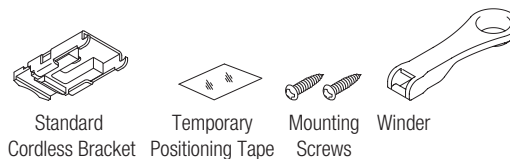

IMPORTANT: Keep the winder with these instructions for future use.

Cassette Cordless

Cassette Installation Brackets Required

Shading Width	Brackets Required
Up to 36"	2
36 1/8" - 72"	3
72 1/8" - 90"	4
90 1/8" - 120"	5

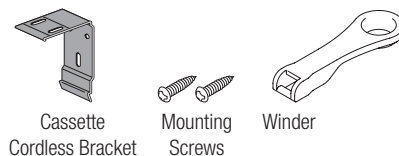

IMPORTANT: Keep the winder with these instructions for future use.

GETTING STARTED

Tools And Fasteners Needed

- Flat head and Phillips screwdriver
- Level
- Measuring tape and pencil
- Power drill and drill bits

In addition, you will need fasteners designed to work with your specific mounting surface(s).

- **#6 hex head screws (provided).** Two 1½" screws are provided per installation bracket.
- **Wall anchors (not provided).** If mounting into drywall, you will need wall anchors to ensure a secure installation.



Mounting Types

Inside Or Ceiling Mount

Install inside a window frame or to the ceiling.

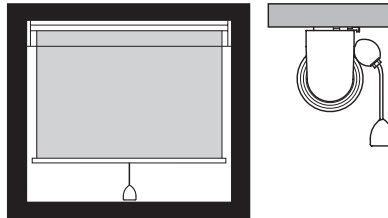

Outside Or Wall Mount

Install on a wall or outside the window frame.

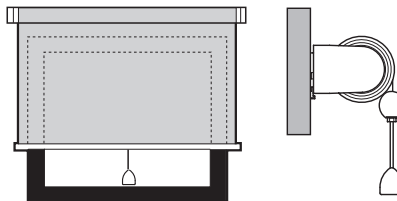

Product Views

Standard Cordless

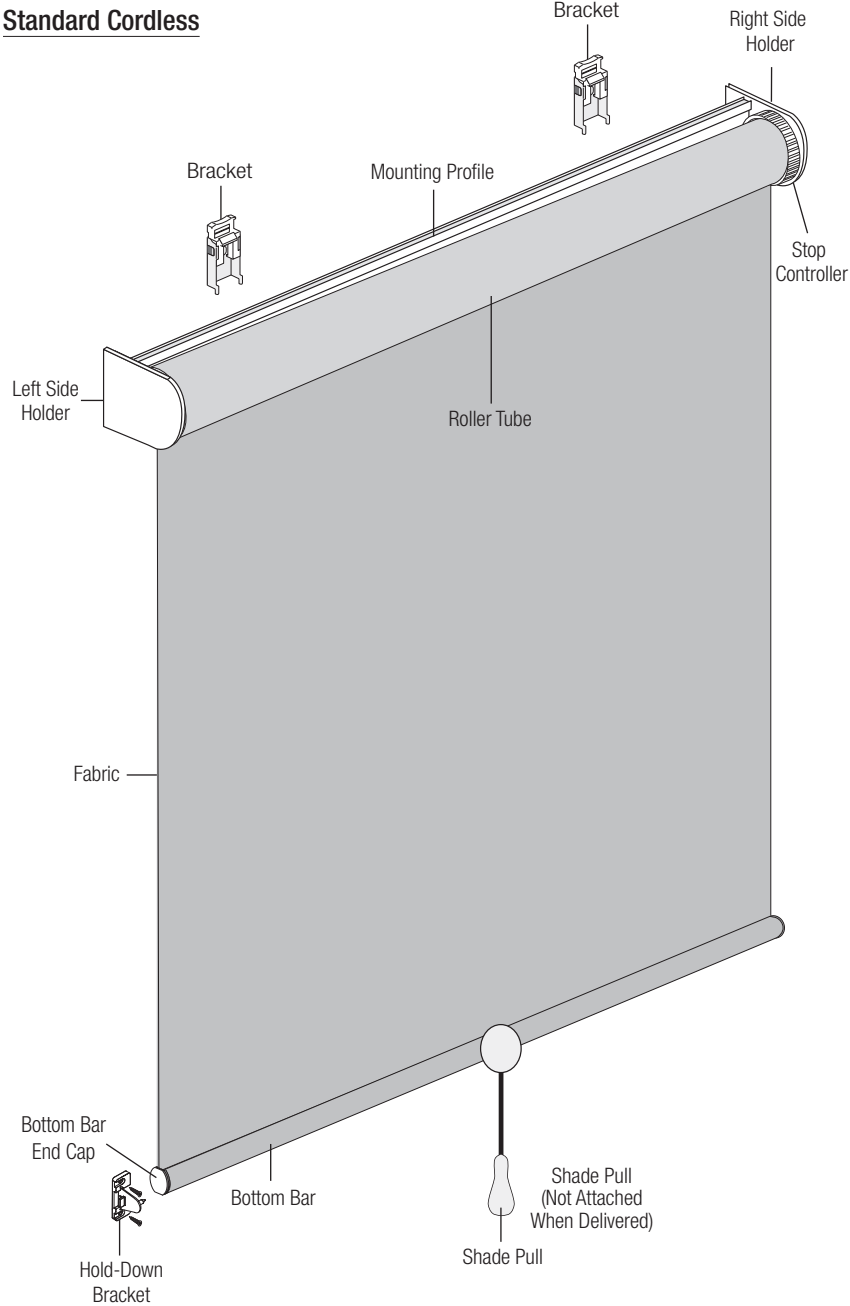

GETTING STARTED

Product Views

Cassette Cordless

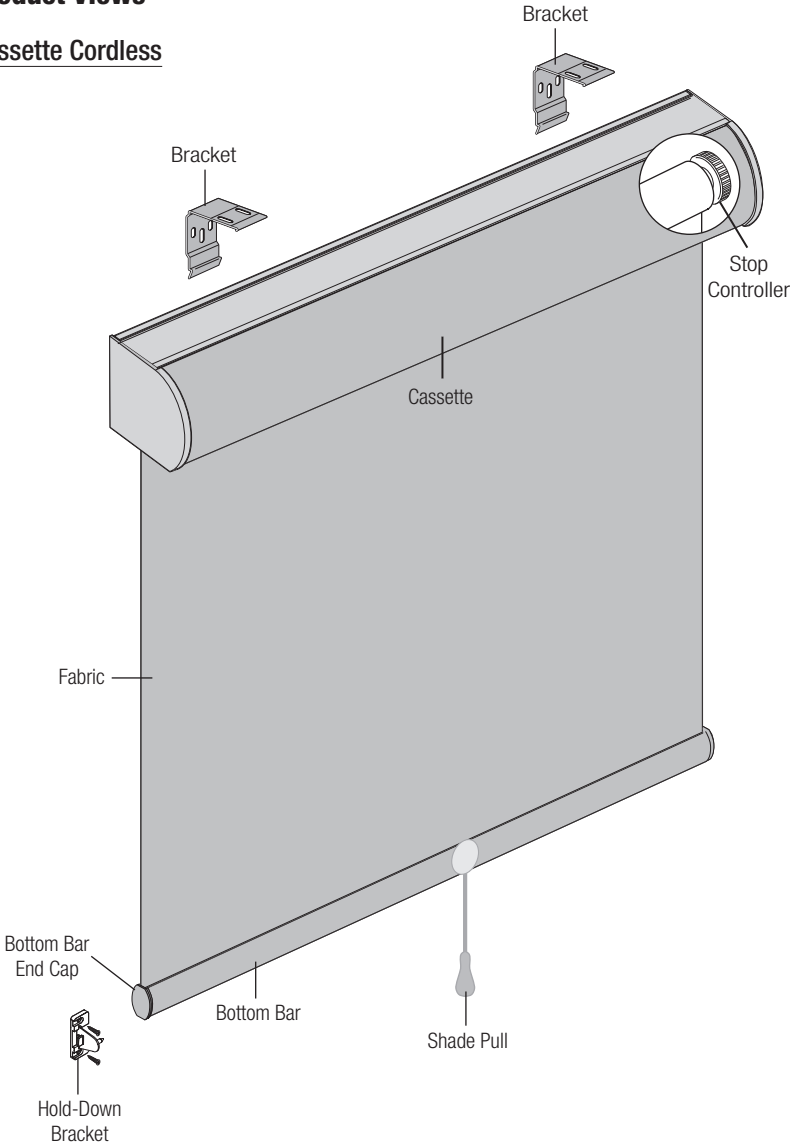

INSTALLATION

Mount The Installation Brackets — Standard Cordless

IMPORTANT: To ensure the bracket is mounted properly, the white tab should be toward the room for an inside or ceiling mount or toward the ceiling for an outside or wall mount.

- Measure 1½" - 3" in from the ends of the mounting profile and mark the bracket locations on the mounting surface.
 - If more than two installation brackets are required for your shade, make additional marks to space the other bracket(s) evenly between the two end brackets. Please refer to the standard cordless bracket chart page 1.
 - Adjust bracket placement to gain clearance to avoid any obstructions, such as window cranks or handles.

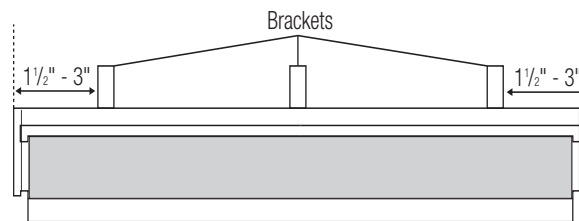

- Center an installation bracket on each mark. Then mark where to drill pilot holes for the mounting screws.
 - With inside mounts, allow ½" clearance behind the brackets for installation.

IMPORTANT: The installation brackets must be mounted level to operate properly.

- Drill pilot holes for the mounting screws. Use a ⅛" drill bit.

IMPORTANT: If you are fastening the mounting brackets to drywall, be sure to use wall anchors and follow the instructions provided with the anchors.

- Fasten the installation brackets to the mounting surface. Use the hex head screws provided with your order.
 - If necessary, use the temporary positioning tape to position the brackets.

IMPORTANT: Outside Mount: the brackets *must be flush against a flat mounting surface*. Do not mount brackets on curved molding. Also, be sure the installation brackets are aligned with each other and level.

IMPORTANT: Inside Mount: be sure the front edges of the brackets are aligned with each other.

INSTALLATION

Mount The Installation Brackets — Cordless Cassette

- Bracket spacing is the same for inside and outside mounted shades.
 - Measure 2" in from where the ends of the cassette will be located and mark the bracket locations on the mounting surface.
 - If more than two installation brackets came with your order, make additional marks to space the other bracket(s) evenly between the two end brackets.
 - Adjust bracket placement to gain clearance to avoid any obstructions, such as window cranks or handles.
 - Center an installation bracket on each mark. Then mark where to drill pilot holes for the mounting screws.
- IMPORTANT:** The installation brackets must be mounted level to operate properly.
- Secure bracket with two screws.

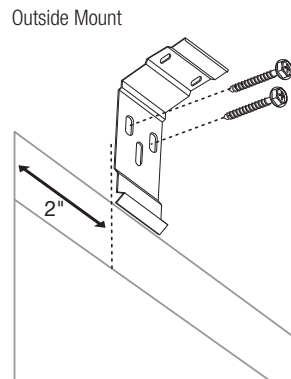
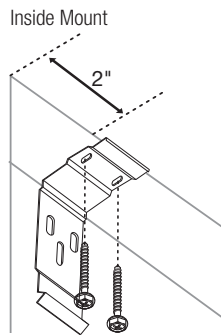
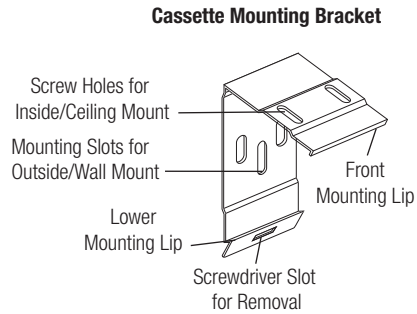

INSTALLATION

Install The Shade

Standard Installation

The groove on the top of the mounting profile fits into the hooks on the installation brackets.

- Install the shade into the installation brackets.
 - Hold the shade so the bottom bar fabric side faces you.
 - Hook the back groove of the mounting profile onto the hooks of the installation brackets.
 - Rotate the mounting profile toward the white tabs of the installation brackets. Push the set bar until tabs lock into place. You will hear a loud click when each bracket is securely in place.

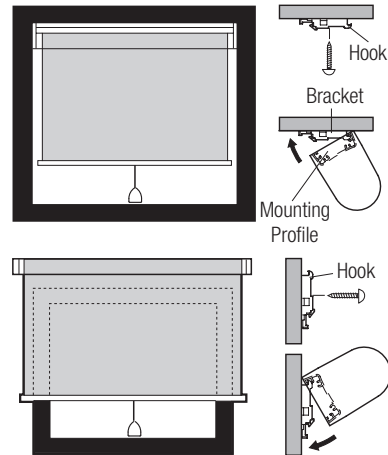

Cassette Installation

- Angle the cassette back and then align the cassette under the front lip of the bracket.
- Push the cassette back to snap it into the lower lip of the bracket.

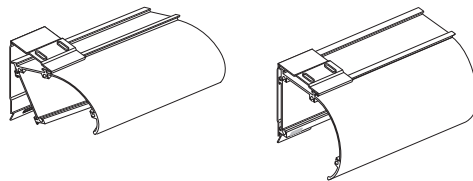

Install The Shade Pull

- The shade pull is not attached when delivered. Detach the screw from the shade pull. Insert the screw through the bottom bar so the screw head is on the back side of the bottom bar.
- Using Phillips head screw driver, attach the shade pull to the facing screw by rotating the screw clockwise. Screw head will be facing the window.
- After the shade is properly installed, remove the "Do not remove until installation" paper from the roll.

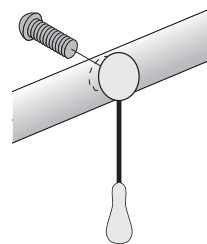

OPERATION

Operate The Shade

Lowering the Shade

- Pull down and release. The shade stops where released.

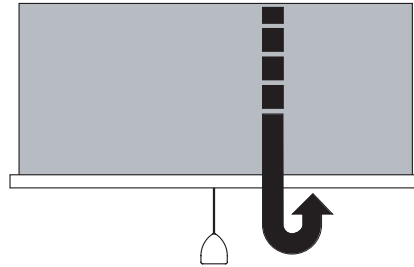

Raising the Shade

- Pull the shade down about an inch and release. The shade rises and stops.

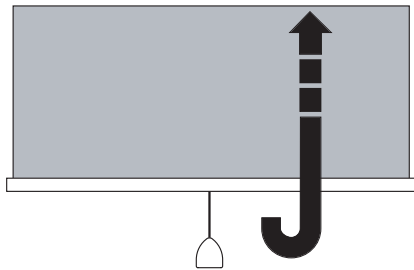

Shade Adjustment

Stop Height Adjustment

The upper level stop height can be adjusted on shades wider than 24". Generally, the shade stops when it is completely rolled up. By using a stop controller, the shade can be adjusted to stop before reaching the top. The stop controller is also useful for aligning multiple side-by-side shades.

- Completely roll up the shade.
- Turn the dial clockwise to lower the fabric level or dial counter-clockwise to raise the fabric level.
- Lower and raise the shade. Repeat the previous step until the stop height is at the desired level.

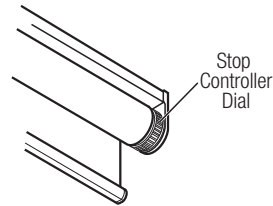

WARNING: When the shade is pulled too hard, bottom of shade may flip over top of roller tube. To fix this, turn the roller tube manually by hand.

Speed Adjustment

If slight changes in the speed are desired:

- Completely raise the shade.
- Turn the left side holder counter-clockwise until it stops.
- Remove the roller from the mounting profile by pulling it out from the right side holder.

WARNING: Remove the shade slowly with both hands.

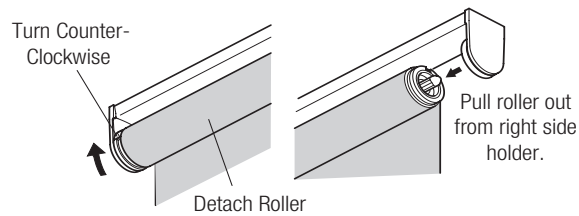

- Lay shade on a flat surface.
- Place the winder onto the black knob on the left side of the roller.

- For faster roll-up:

- Turn 1-2 times clockwise as pictured while pulling the winder.

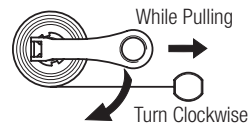

- For slower roll-up:

- While pulling the winder, turn a half-turn clockwise, then turn 1-2 times counter-clockwise.

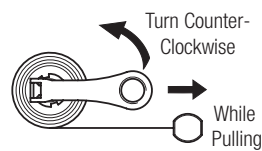
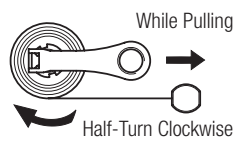

- Replace the roller by aligning it in the right side holder.
- Slide the left side black knob into the side holder. The red side of the knob should be facing up.
- Turn the left side holder clockwise until it stops.

CAUTION: The winder does not turn if it is not pulled. Do not turn it more than two turns. Hold the winder securely, otherwise it may slip from the knob and cause injury.

OPERATION

Troubleshooting

Problem	Solution
The shade does not roll up, or it rolls too slowly.	<ul style="list-style-type: none">■ Check that the mounting brackets are level.■ Roll-up speed can be adjusted. See <i>"Speed Adjustment"</i>, page 9.
The shade does not lower.	<ul style="list-style-type: none">■ Check that the window is square by measuring the diagonals.■ Check that the left side holder dial is closed. The shade will not operate if it is in the open position. <p>WARNING: Do not disassemble or modify the mechanism inside the roll tube.</p>
I have several shades, and the side holders are different sizes.	<ul style="list-style-type: none">■ Shade holder size is determined by the length of the shade and size of the roll.

Standard Cordless Shade Removal

- Fully raise the shade.
- While holding the shade, push in the white tab on each bracket to release.

Cordless With Cassette Shade Removal

- While holding the cassette with one hand, insert the end of a flat head screwdriver into the slot in the bottom of the cassette mounting brackets and pry the bottom of the cassette mounting brackets down slightly to release the bottom of the cassette from the lower lip.
- Rotate the bottom edge of the cassette out and pull the cassette away from the front lip of the cassette mounting bracket.

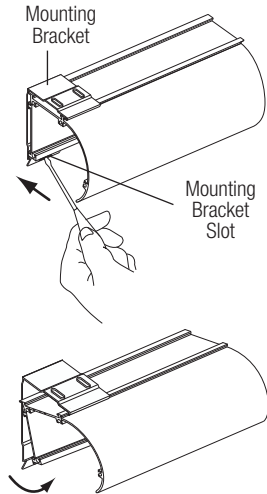

Cleaning Procedures

The following options are available if your shade needs cleaning.

Dusting

- Regular light dusting with a feather duster or soft cloth is all the cleaning that is needed in most circumstances.

Vacuuming

- Use a hand-held vacuum with low suction for more thorough dust removal.

CAUTION: Do not clean with harsh detergents.

For more cleaning methods specific to your roller shade fabric, please consult your Hunter Douglas dealer.

HunterDouglas

LIGHT CAN CHANGE EVERYTHING®

hunterdouglas.com

LIT888315



1/08